

SIRIUS HRI brand

Hochdruck-Entladungslampen mit Reflektor



Anwendungsgebiete

- Konzertbeleuchtung
- Club und Disco
- Bühne und Theater
- Studio, TV und Film
- Architecture & Architainment

Produktfamilien-Vorteile

- Leichte und kompakte Reflektorlampen
- Perfekt geeignet für kleine und leichte Moving Heads
- Optimiertes Brennerdesign ermöglicht jede Brennstellung
- Hohe Leuchtdichte durch sehr kurzen Lichtbogen und hohen Druck
- Helles Licht für brillante Lichteffekte
- Lange Lebensdauer
- Einfacher Lampenwechsel
- Gleichmäßige Lichtausbeute über die gesamte Lebensdauer



Familiendatenblatt

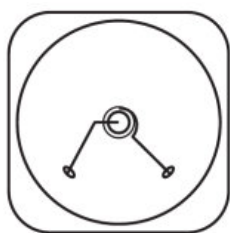
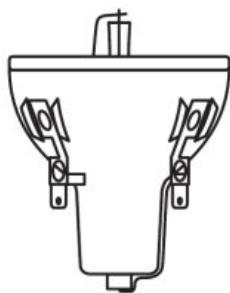

666507_SIRIUS HRI 100W

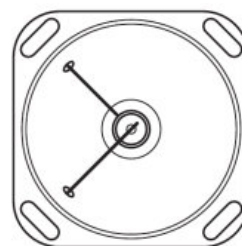
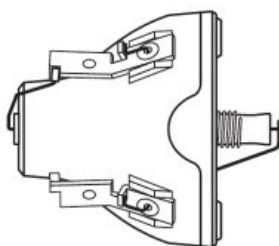

350611_SIRIUS HRI 132W

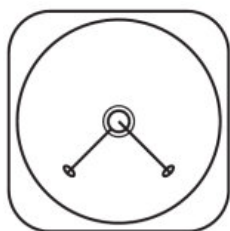
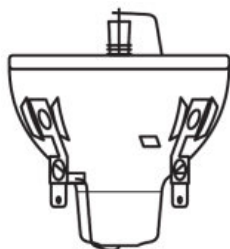

488735_SIRIUS HRI 132W

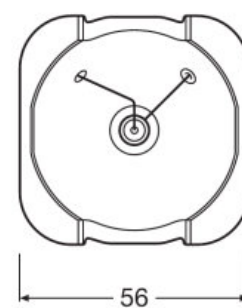
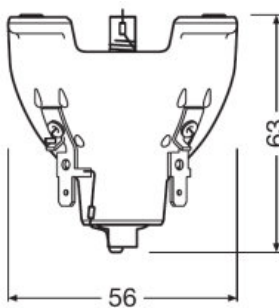

501950_SIRIUS HRI 330W

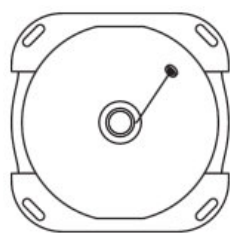
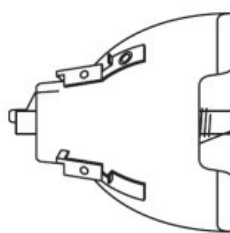

333382_SIRIUS HRI 330W

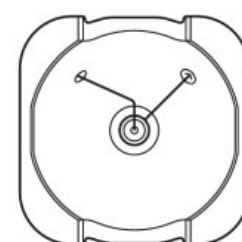
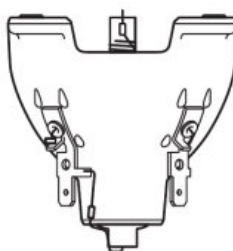

501965_SIRIUS HRI 330W

Familiendatenblatt

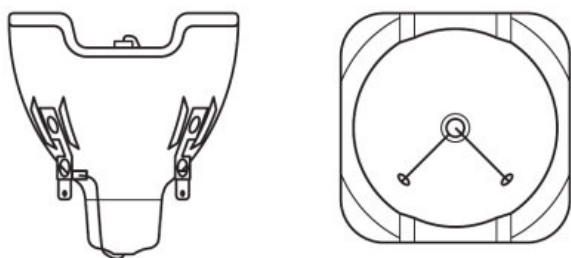

488771_SIRIUS HRI 330W X8

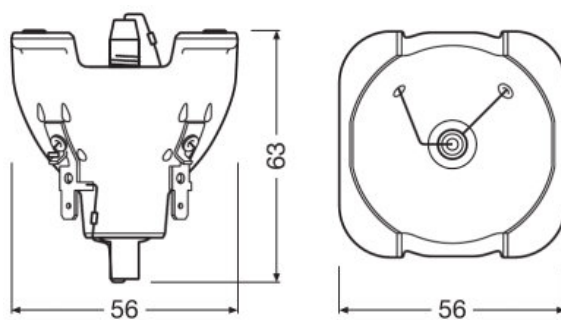

501949_Sirius HRI 330W XL

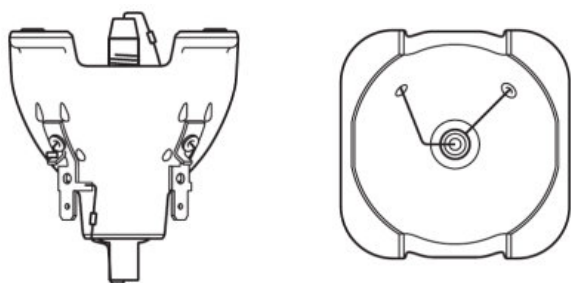

501963_Sirius HRI 330W XL

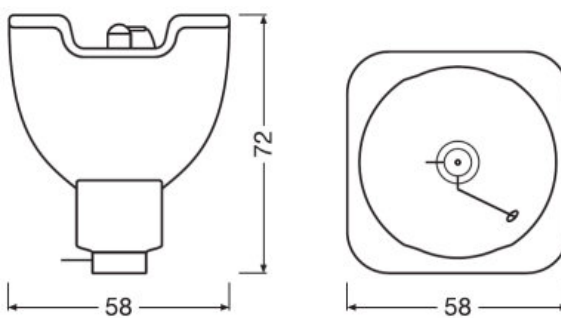

SIRIUS HRI 371W

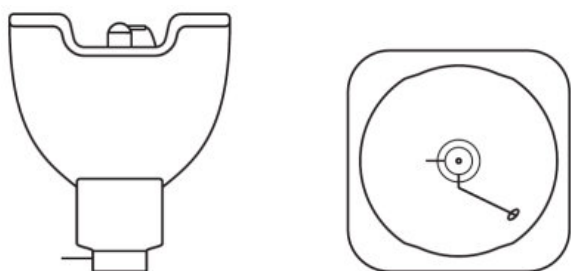

SIRIUS HRI 371W

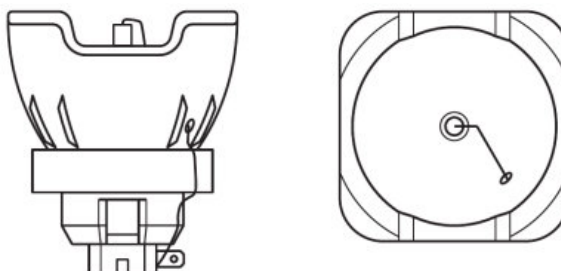

668858_SIRIUS HRI 440W

Technische Daten

Produkt-Bezeichnung	Elektrische Daten		Photometrische Daten				Lichttechnische Daten
	Nennleistung	Nennstrom	Nennlichtstrom	Farbtemperatur	Farbwiedergabeindex Ra	Maximale Farbtemperatur	Auflagemaß
SIRIUS HRI 100 W	100,00 W	1,8 A	3680 lm	9000 K	60	9300 K	30.0 mm
SIRIUS HRI 132 W SC	132,00 W	1,8 A	5150 lm	9200 K	60	9200 K	37.7 mm
SIRIUS HRI 140 W RO	140,00 W	1,9 A	5400 lm	9200 K	60	9200 K	37.7 mm
SIRIUS HRI 190 W+	190,00 W	2,7 A	8100 lm	8200 K	73		
SIRIUS HRI 230 W	230,00 W	3,3 A	9500 lm	8000 K	75	8000 K	34,5 mm
SIRIUS HRI 231 W	231,00 W	3,3 A	10800 lm	8000 K	75		
SIRIUS HRI 251 W	250,00 W	3,5 A	12000 lm	8000 K	77		
SIRIUS HRI 260 W PRO	260,00 W	3,7 A	13500 lm	7800 K	79		
SIRIUS HRI 280 W	280,00 W	4 A	11500 lm	7800 K	78	7800 K	35.5 mm
SIRIUS HRI 280 W RO	280,00 W	4 A	11500 lm	7800 K	78		
SIRIUS HRI 281 W	281,00 W	4 A	13000 lm	7800 K	78		
SIRIUS HRI 310 W PRO	310,00 W	5 A	15500 lm	7650 K	85		
SIRIUS HRI 311 W	310,00 W	3,3 A	14500 lm	8000 K	75		
SIRIUS HRI 330 W	330,00 W	5 A	18000 lm	7400 K	86	7400 K	31.0 mm
SIRIUS HRI 330 W X8	330,00 W	4,4 A	18000 lm	8000 K	85		
SIRIUS HRI 330 W XL	330,00 W	5 A	16500 lm	7250 K	71		
SIRIUS HRI 370W LL	370,00 W	5 A	18000 lm	7400 K	86		
SIRIUS HRI 371 W	371,00 W	5 A	18300 lm	7650 K	85		
SIRIUS HRI 371 W S	371,00 W	5 A	19800 lm	7650 K	85		
SIRIUS HRI 371 W +	370,00 W	5 A	18300 lm	7650 K	85		
HRI 371 W S +	370,00 W	5 A	19800 lm	7650 K	85		
SIRIUS HRI 380 W Pro	380,00 W	5 A	20000 lm	7700 K	85		
SIRIUS HRI 420 W	420,00 W	5 A	22000 lm	7700 K	85		
SIRIUS HRI 440 W	440,00 W	5,3 A	20000 lm	7000 K	80	7000 K	41.0 mm
SIRIUS HRI 440 W H	440,00 W	5,3 A	18000 lm	7000 K	75		
SIRIUS HRI 440 W S	440,00 W	4,4 A	22800 lm	7000 K	80		
SIRIUS HRI 440 W X	440,00 W	5,3 A	22800 lm	7000 K	80		
SIRIUS HRI 461 W	461,00 W	5,3 A	24000 lm	7500 K	80		
SIRIUS HRI 461 W S	461,00 W	5,3 A	24000 lm	7500 K	80		
SIRIUS HRI 470 W S	470,00 W	5,3 A	21500 lm	7000 K	80		
SIRIUS HRI 470 W RO	470,00 W	5,3 A	19500 lm	7500 K	80		
SIRIUS HRI 470 W XL	470,00 W	5,3 A	24000 lm	7500 K	80		
SIRIUS HRI 471 W SN	471,00 W	5,3 A	20000 lm	7500 K	80		
SIRIUS HRI 550 W	550,00 W	6,1 A	28000 lm	7000 K	75		

Familiendatenblatt

Produkt-Bezeichnung	Apertur-Fenster max.	Abmessungen & Gewicht		Lebensdauer	Einsatzmöglichkeiten	
		Durchmesser	Länge	Lebensdauer	Brennstellung	Kühlung
SIRIUS HRI 100 W	5x3.8 mm	45,0 mm	53,0 mm	6000 h	Beliebig	Forciert
SIRIUS HRI 132 W SC	5x3.8 mm	46,0 mm	max. 44 mm	6000 h	Beliebig	Forciert
SIRIUS HRI 140 W RO	5x3.8 mm	46,0 mm	max. 44 mm	6000 h	Beliebig	Forciert
SIRIUS HRI 190 W+		51,0 mm	54,5 mm			
SIRIUS HRI 230 W	5x3.8 mm	51,0 mm	54,5 mm	2500 h	Beliebig	Forciert
SIRIUS HRI 231 W		51,0 mm	50,0 mm	2000 h	Beliebig	
SIRIUS HRI 251 W		51,0 mm	61,0 mm	3000 h		
SIRIUS HRI 260 W PRO		51,0 mm	50,0 mm	6000 h		
SIRIUS HRI 280 W	5x3.8 mm	51,0 mm	54,5 mm	2000 h	Beliebig	Forciert
SIRIUS HRI 280 W RO		51,0 mm	54,5 mm	2000 h	Beliebig	
SIRIUS HRI 281 W		51,0 mm	50,0 mm	2000 h	Beliebig	
SIRIUS HRI 310 W PRO		58,0 mm	72,0 mm	6000 h		
SIRIUS HRI 311 W		51,0 mm	50,0 mm	1500 h		
SIRIUS HRI 330 W	8.0 mm	56,0 mm	63,0 mm	1500 h	Beliebig	Forciert
SIRIUS HRI 330 W X8		58,0 mm	66,0 mm	1500 h	Beliebig	
SIRIUS HRI 330 W XL		56,0 mm	63,0 mm	1500 h	Beliebig	
SIRIUS HRI 370W LL		58,0 mm	72,0 mm	6000 h	Beliebig	
SIRIUS HRI 371 W		58,0 mm	72,0 mm	1500 h	Beliebig	
SIRIUS HRI 371 W S		58,0 mm	72,0 mm	1500 h	Beliebig	
SIRIUS HRI 371 W +		58,0 mm	72,0 mm	3000 h		
HRI 371 W S +		58,0 mm	72,0 mm	3000 h		
SIRIUS HRI 380 W Pro		58,0 mm	72,0 mm	2500 h		
SIRIUS HRI 420 W		58,0 mm	72,0 mm	2500 h		
SIRIUS HRI 440 W	8.0 mm	58,0 mm	71,0 mm	1500 h	Beliebig	Forciert
SIRIUS HRI 440 W H		65,0 mm	60,0 mm	1500 h	Beliebig	
SIRIUS HRI 440 W S		11,8 mm	71,0 mm	1500 h	Beliebig	
SIRIUS HRI 440 W X		58,0 mm	71,0 mm	1500 h		
SIRIUS HRI 461 W		60,0 mm	67,0 mm	1500 h	Beliebig	
SIRIUS HRI 461 W S		60,0 mm	67,0 mm	1500 h	Beliebig	
SIRIUS HRI 470 W S		58,0 mm	71,0 mm	1500 h	Beliebig	
SIRIUS HRI 470 W RO		60,0 mm	67,0 mm	1500 h	Beliebig	
SIRIUS HRI 470 W XL		60,0 mm	67,0 mm	1500 h	Beliebig	
SIRIUS HRI 471 W SN		60,0 mm	67,0 mm	1500 h	Beliebig	
SIRIUS HRI 550 W		60,0 mm	67,0 mm	1500 h		

Produkt-Bezeichnung	Zertifikate & Standards	Umwelt Informationen Informationen gemäß Art. 33 der EU Richtlinie (EC) 1907/2006 (REACH)		
	EEI – Energieeffizienz- klasse	Datum der Deklaration	Primäre Erzeugnisnummer	SCIP Deklarationsnummer
SIRIUS HRI 100 W	B	07-04-2022	4052899321656 4052899329119	In Vorbereitung
SIRIUS HRI 132 W SC	A	07-04-2022	4052899011335 4052899028708 4052899197404	In Vorbereitung

Familiendatenblatt

Produkt-Bezeichnung	Zertifikate & Standards	Umwelt Informationen Informationen gemäß Art. 33 der EU Richtlinie (EC) 1907/2006 (REACH)		
	EEI – Energieeffizienz- klasse	Datum der Deklaration	Primäre Erzeugnisnummer	SCIP Deklarationsnummer
SIRIUS HRI 140 W RO	A	21-04-2023	4052899224056 4052899258969	In Vorbereitung
SIRIUS HRI 190 W+		10-02-2023	4008321866592 4052899475397	In Vorbereitung
SIRIUS HRI 230 W	A	07-04-2022	4008321678225 4008321810311	In Vorbereitung
SIRIUS HRI 231 W	A	07-04-2022	4052899512634 4052899553521 4062172041430 4062172128681 4062172212311	In Vorbereitung
SIRIUS HRI 251 W		03-02-2023	4062172212458 4062172212434	In Vorbereitung
SIRIUS HRI 260 W PRO		07-04-2022	4062172118941 4062172118927	In Vorbereitung
SIRIUS HRI 280 W	A	07-04-2022	4008321734303 4008321810342 4052899110397	In Vorbereitung
SIRIUS HRI 280 W RO	A	07-04-2022	4052899082151	Kein deklarationspflichtiger Stoff enthalten
SIRIUS HRI 281 W	A	03-02-2023	4052899553552 4062172041454 4062172128704	In Vorbereitung
SIRIUS HRI 310 W PRO		07-06-2023	4062172085304 4062172169424 4062172169455	In Vorbereitung
SIRIUS HRI 311 W		03-02-2023	4062172169363	In Vorbereitung
SIRIUS HRI 330 W		07-04-2022	4008321754448 4008321810373	In Vorbereitung
SIRIUS HRI 330 W X8	A	07-04-2022	4052899140295 4052899140325 4052899224346	In Vorbereitung
SIRIUS HRI 330 W XL		07-04-2022	4008321848765 4052899195431	In Vorbereitung
SIRIUS HRI 370W LL		07-04-2022	4052899569188 4062172056816	In Vorbereitung
SIRIUS HRI 371 W		26-08-2022	4062172057004 4062172056984 4052899558649 4052899558670	In Vorbereitung
SIRIUS HRI 371 W S		07-04-2022	4062172056953 4062172056939 4052899558618	In Vorbereitung
SIRIUS HRI 371 W +		07-06-2023	4062172110341 4062172110327	In Vorbereitung
HRI 371 W S +		07-04-2022	4062172110396 4062172110372	In Vorbereitung

Familiendatenblatt

Produkt-Bezeichnung	Zertifikate & Standards	Umwelt Informationen Informationen gemäß Art. 33 der EU Richtlinie (EC) 1907/2006 (REACH)		
	EEI – Energieeffizienz- klasse	Datum der Deklaration	Primäre Erzeugnisnummer	SCIP Deklarationsnummer
SIRIUS HRI 380 W Pro		11-04-2022	4062172168625 4062172168601	In Vorbereitung
SIRIUS HRI 420 W		07-04-2022	4062172192750 4062172192736	In Vorbereitung
SIRIUS HRI 440 W	A	07-04-2022	4052899222212 4052899259096 4052899553644 4052899570566 4052899587892	In Vorbereitung
SIRIUS HRI 440 W H		07-04-2022	4052899509528 4052899576735	In Vorbereitung
SIRIUS HRI 440 W S	A	07-04-2022	4052899276543 4052899329140	In Vorbereitung
SIRIUS HRI 440 W X		07-04-2022	4062172017442	Kein deklarationspflichtiger Stoff enthalten
SIRIUS HRI 461 W		07-04-2022	4052899532274 4052899553613	Kein deklarationspflichtiger Stoff enthalten
SIRIUS HRI 461 W S		07-04-2022	4052899532298 4052899553583	Kein deklarationspflichtiger Stoff enthalten
SIRIUS HRI 470 W S		07-04-2022	4052899580985 4062172169301	In Vorbereitung
SIRIUS HRI 470 W RO	A	07-04-2022	4052899476998 4052899477018	In Vorbereitung
SIRIUS HRI 470 W XL		07-04-2022	4052899581166 4062172017473 4062172168281	In Vorbereitung
SIRIUS HRI 471 W SN		07-04-2022	4052899581005 4062172040358	In Vorbereitung
SIRIUS HRI 550 W		07-04-2022	4062172008761 4062172078122	In Vorbereitung

Produkt-Bezeichnung	Stoff der Kandidatenliste 1
SIRIUS HRI 100 W	
SIRIUS HRI 132 W SC	No declarable substances contained
SIRIUS HRI 140 W RO	No declarable substances contained
SIRIUS HRI 190 W+	No declarable substances contained
SIRIUS HRI 230 W	No declarable substances contained
SIRIUS HRI 231 W	No declarable substances contained

Familiendatenblatt

Produkt-Bezeichnung	Stoff der Kandidatenliste 1
SIRIUS HRI 251 W	
SIRIUS HRI 260 W PRO	
SIRIUS HRI 280 W	No declarable substances contained
SIRIUS HRI 280 W RO	No declarable substances contained
SIRIUS HRI 281 W	No declarable substances contained
SIRIUS HRI 310 W PRO	
SIRIUS HRI 311 W	
SIRIUS HRI 330 W	No declarable substances contained
SIRIUS HRI 330 W X8	No declarable substances contained
SIRIUS HRI 330 W XL	No declarable substances contained
SIRIUS HRI 370W LL	No declarable substances contained
SIRIUS HRI 371 W	No declarable substances contained
SIRIUS HRI 371 W S	No declarable substances contained
SIRIUS HRI 371 W + HRI 371 W S +	
SIRIUS HRI 380 W Pro	
SIRIUS HRI 420 W	
SIRIUS HRI 440 W	No declarable substances contained
SIRIUS HRI 440 W H	No declarable substances contained
SIRIUS HRI 440 W S	No declarable substances contained
SIRIUS HRI 440 W X	No declarable substances contained
SIRIUS HRI 461 W	No declarable substances contained
SIRIUS HRI 461 W S	No declarable substances contained
SIRIUS HRI 470 W S	
SIRIUS HRI 470 W RO	No declarable substances contained
SIRIUS HRI 470 W XL	No declarable substances contained
SIRIUS HRI 471 W SN	No declarable substances contained
SIRIUS HRI 550 W	

Familiendatenblatt

Sicherheitshinweise

Wegen ihrer hohen Leuchtdichte, der abgegebenen UV-Strahlung und des hohen Lampeninnendruckes während des Betriebs dürfen SIRIUS HRI-Lampen nur in geschlossenen und eigens dafür konstruierten Gehäusen betrieben werden. Durch passende Filter muss sichergestellt werden, dass die UV-Strahlung auf ein akzeptables Niveau verringert wird. Im Falle des Platzens einer Lampe wird Quecksilber freigesetzt. Es sind besondere Sicherheitsregeln zu beachten. Nähere Hinweise hierzu erhalten Sie auf Anfrage oder entnehmen Sie bitte dem Beipackzettel bzw. der Bedienungsanleitung.

Anwendungshinweis

Für weitere Anwendungsinformationen beachten Sie bitte das Produktdatenblatt.

Haftungsausschluss

Änderungen und Irrtümer vorbehalten. Vergewissern Sie sich, dass Sie immer den neuesten Stand verwenden.